

# Back-to-back free-standing cascade configuration - 400 kW

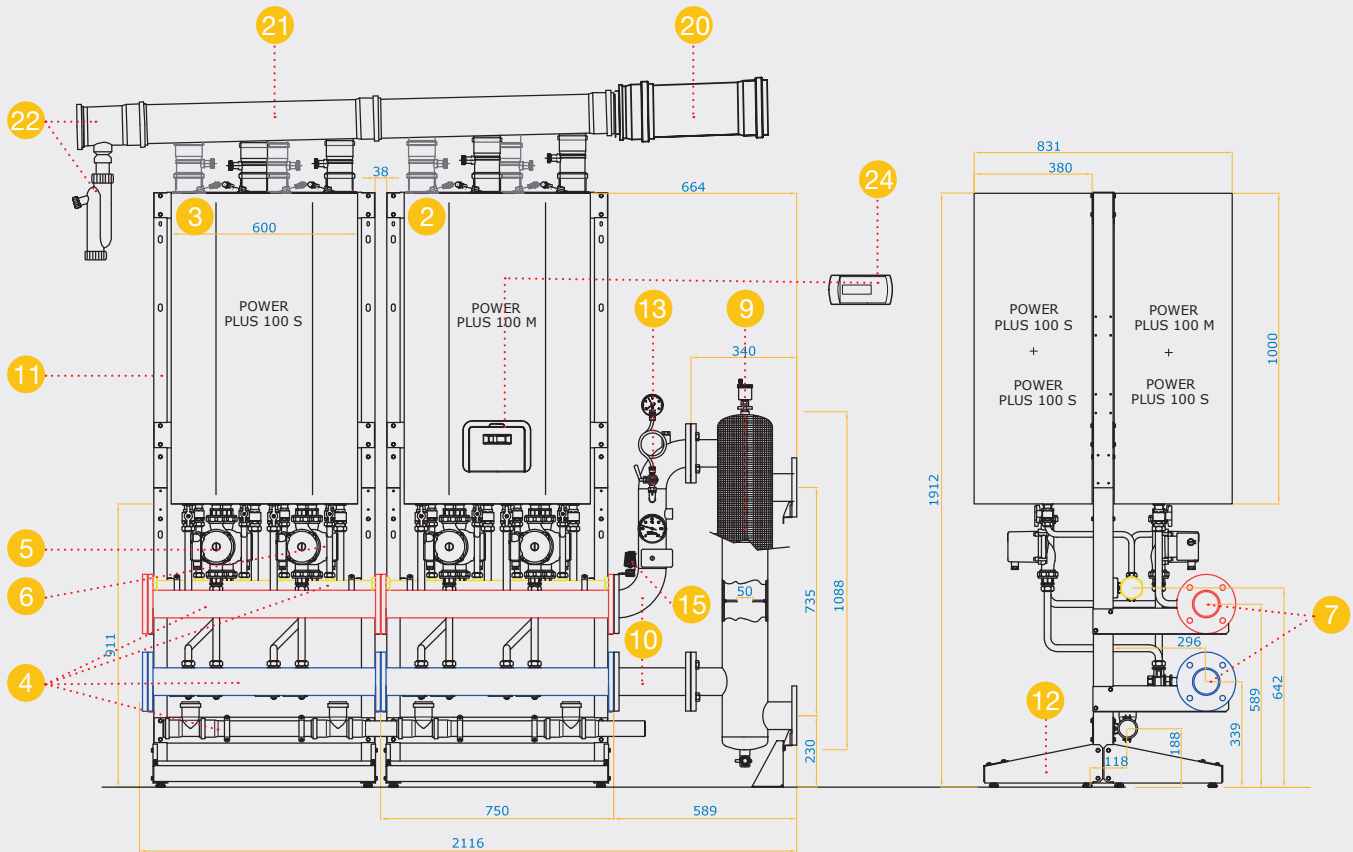

This scheme has only an indication purpose

diagram ref.	code	description	quantity
<b>BOILERS</b>			
2	20019200	Power Plus 100 M	1
3	20019309	Power Plus 100 S	3
<b>USER INTERFACE</b>			
24	1102379*	Remote control	1
<b>HYDRAULIC COMPONENTS and SAFETY DEVICES</b>			
4	20009439	Hydraulic manifold kit up to 400 kW for Power Plus rig	2
7	20009444	Blank end-flange kit for hydraulic manifold	1
5	20009442	Pump kit (front) for Power Plus rig	4
6	20009443	Pump kit (rear) for Power Plus rig	4
9	20009467	Hydraulic header/separator - 250-400 kW	1
10	20009471	ISPESL hydraulic manifold	1
13	20009475*	ISPESL safety kit (400 kW max.)	1
15	20009483*	Gas safety cut-off valve (400 kW max.)	1
<b>SUPPORTS for BACK-TO-BACK FREE-STANDING MOUNTING</b>			
11	20009472	Power Plus rig (front mounting)	2
12	20009474	Rear mounting kit for Power Plus free-standing rig	2

diagram ref.	code	description	quantity
<b>FLUES</b>			
21	4030312	Flues collector kit Ø 125 for 100 kW	4
20	20017306	Flues collector kit for frontal/rear installation	1
22	4030031	Condensate drain kit Ø 125 whit tap	2

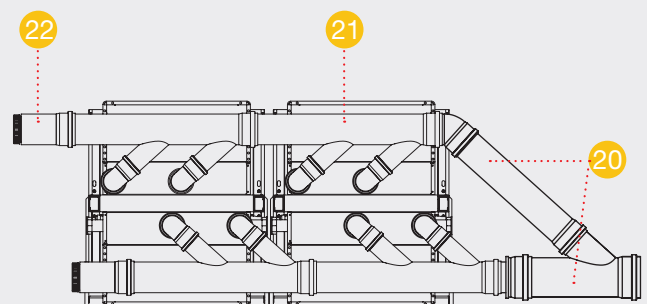

\* OPTIONAL component